

Low Power Low Offset Voltage Dual Comparators

The SL393 consists of two independent precision voltage comparators with an offset voltage specification as low as 2.0 mV max for two comparators which were designed specifically to operate from a single power supply over a wide range of voltages.

Application areas include limit comparators, simple analog to digital converters; pulse, square wave and time delay generators; wide range VCO; MOS clock timers; multi vibrators and high voltage digital logic gates.

- Single or Split Supply Operation
- Low Input Bias Current
- Low Input Offset Current
- Input Common Mode Voltage Range to Gnd
- Low Output Saturation Voltage
- TTL and CMOS Compatible

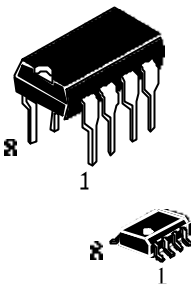

**N SUFFIX
PLASTIC**

**D SUFFIX
SOIC**

ORDERING INFORMATION
 SL393N Plastic
 SL393D SOIC
 T_A = -20° to 70° C for all packages.

LOGIC DIAGRAM

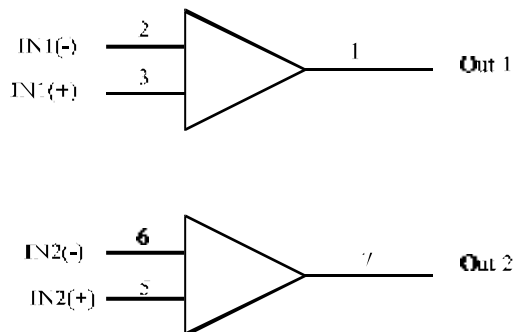

PIN 8 = V_{CC}
 PIN 4 = GND

PIN ASSIGNMENT

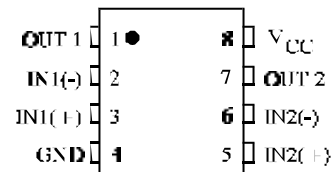

SL393

MAXIMUM RATINGS*

Symbol	Parameter	Value	Unit
V_{CC}	Power Supply Voltages		
	Single Supply	36	V
	Split Supplies	± 18	
V_{IDR}	Input Differential Voltage Range	36	V
V_{ICR}	Input Common Mode Voltage Range (1)	-0.3 to V_{CC}	V
I_{SC}	Output Short Circuit to Ground	Continuous	
I_{IN}	Input Current, per pin (2)	50	mA
T_J	Junction Temperature		
	Plastic Packages	150	$^{\circ}\text{C}$
T_{stg}	Storage Temperature	-65 to $+150$	$^{\circ}\text{C}$
T_L	Lead Temperature, 1mm from Case for 10 Seconds	260	$^{\circ}\text{C}$
P_D	Power Dissipation @ $T_A=25^{\circ}\text{C}$		
	Plastic Package	570	μW
	Derate above 25°C	5.7	$\text{mW}/^{\circ}\text{C}$

*Maximum Ratings are those values beyond which damage to the device may occur. Functional operation should be restricted to the Recommended Operating Conditions.

Notes:

1. Split Power Supplies.
2. $V_{IN} < -0.3\text{V}$. This input current will only exist when voltage at any of the input leads is driven negative.

RECOMMENDED OPERATING CONDITIONS

Symbol	Parameter	Min	Max	Unit
V_{CC}	DC Supply Voltage	± 2.5 or 5.0	± 15 or 30	V
T_A	Operating Temperature, All Package Types	-20	+70	$^{\circ}\text{C}$

This device contains protection circuitry to guard against damage due to high static voltages or electric fields. However, precautions must be taken to avoid applications of any voltage higher than maximum rated voltages to this high-impedance circuit. For proper operation, V_{IN} and V_{OUT} should be constrained to the range $\text{GND} \leq (V_{IN} \text{ or } V_{OUT}) \leq V_{CC}$.

Unused inputs must always be tied to an appropriate logic voltage level (e.g., either GND or V_{CC}). Unused outputs must be left open.



DC ELECTRICAL CHARACTERISTICS ($T_A = -20$ to $+70^\circ\text{C}$)

Symbol	Parameter	Test Conditions	Guaranteed Limit			Unit
			Min	Typ	Max	
V_{IO}	Input Offset Voltage	$V_0=1.4\text{V}$ $V_{CC}=5.0\text{-}30\text{V}; R_S \leq 100\Omega$ $V_{ICR}=0\text{V} - (V_{CC}-1.5)\text{V}$	-		9.0	mV
I_{IB}	Input Bias Current	$V_0=1.4\text{V}$ $V_{CC}=5.0\text{-}30\text{V}$ $V_{ICR}=0\text{V} - (V_{CC}-1.5)\text{V}$	-		400	nA
I_{IO}	Input Offset Current	$V_0=1.4\text{V}$ $V_{CC}=5.0\text{-}30\text{V}$ $V_{ICR}=0\text{V} - (V_{CC}-1.5)\text{V}$	-		± 150	nA
V_{ICR}	Input Common Mode Voltage Range	$V_{CC}=5.0\text{-}30\text{V}$	0		$V_{CC}-2.0\text{V}$	V
I_{CC}	Supply Current	$R_L = \infty, V_{CC}=5.0$ $R_L = \infty, V_{CC}=30\text{V}$	-		1.0* 2.5*	mA
A_{VOL}	Voltage Gain	$V_{CC}=15\text{V}, R_L=15\text{K}\Omega$	-	200*	-	V/mV
t_1	Large Signal Response Time	$V_{IN}=\text{TTL Logic Swing}$, $V_{ref}=1.4\text{V}, V_{CC}=5.0\text{V}$, $R_L=5.1\text{K}\Omega, V_{RL}=5.0\text{V}$	-	300*	-	ns
t_2	Response Time (Note 6)	$V_{CC}=5.0\text{V}, R_L=5.1\text{K}\Omega$, $V_{RL}=5.0\text{V}$	-	1.3*	-	μs
I_{sink}	Output Sink Current	$V_1(-)=1.0\text{V}, V_1(+)=0\text{V}, V_0 \leq 1.5\text{V}$, $V_{CC}=5.0\text{V}$	6.0*	-	-	mA
V_{sat}	Saturation Voltage	$V_1(-)=1.0\text{V}, V_1(+)=0\text{V}$, $I_{sink} \leq 4.0\text{mA}, V_{CC}=5.0\text{V}$	-	-	700	mV
I_{OL}	Output Leakage Current	$V_1(+)=1.0\text{V}, V_1(-)=0\text{V}, V_0=5.0\text{V}$ $V_0=30\text{V}$		0.1*	1000	nA
V_{IDR}	Differential Input Voltage Range	All $V_{IN} \geq \text{GND}$ or V-Supply (if used)			V_{CC}	V

*=@25°C

TYPICAL PERFORMANCE CHARACTERISTICS

($V_{CC}=1.5V$, $T_A=+25^{\circ}C$, (each comparator))

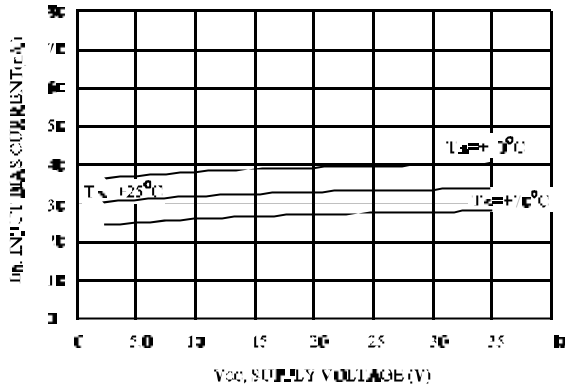

Figure 1. Input Bias Current versus Power Supply Voltage

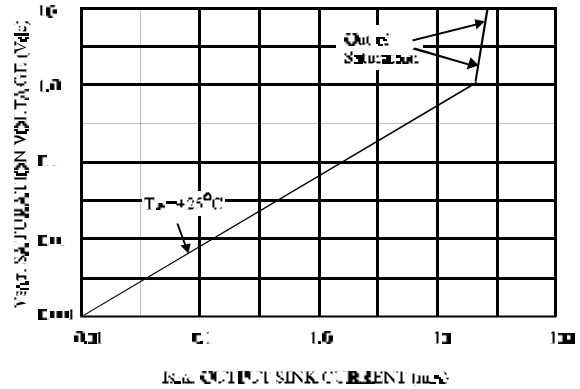

Figure 2. Output Saturation Voltage versus Output Sink Current

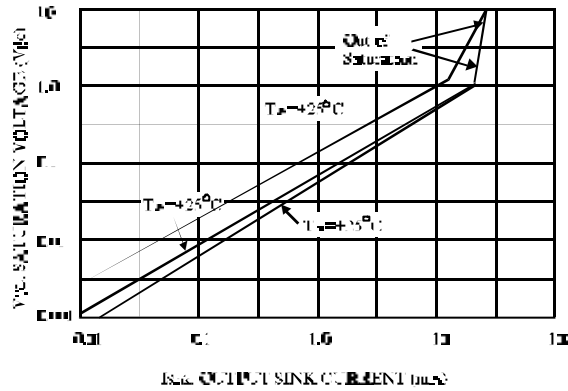

Figure 3. Output Saturation Voltage versus Output Sink Current

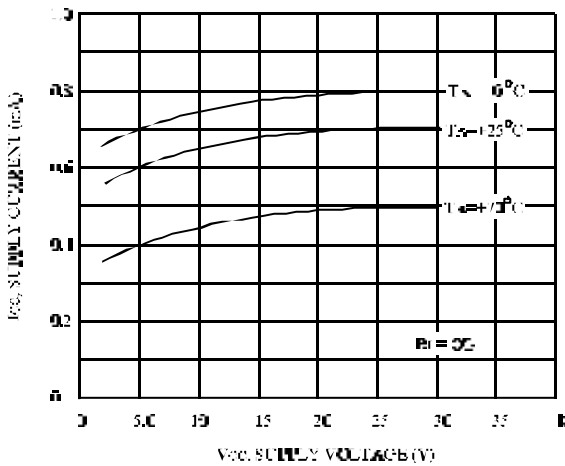

Figure 4. Power Supply Current versus Power Supply Voltage

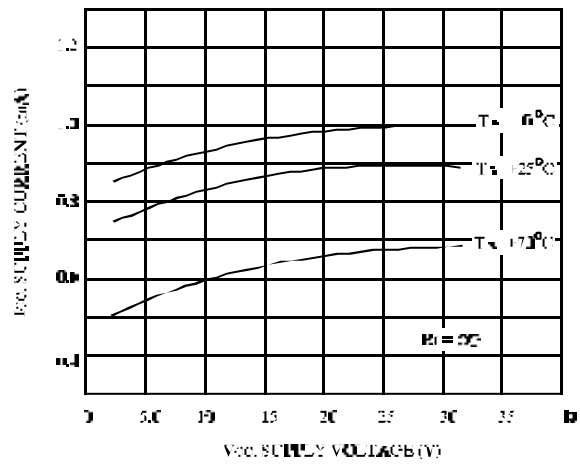

Figure 5. Power Supply Current versus Power Supply Voltage